

Support
www.randmcnally.com/support
877-446-4863



ClearDryve™ Quick Start Guide



ClearDryve™ 100



ClearDryve™ 200



ClearDryve™ 100



ClearDryve™ 200

Contents

What's in the box	2
ClearDryve™ Parts	3
Function Button Layout.....	4
Getting Started with ClearDryve™	6
Charge the Battery	6
Power ClearDryve™ On and Off.....	7
Pair With a Device over Bluetooth®	7
Call Mode	9
Quick Access	9
Answer an Incoming Call	10
End a Call	10
Ignore an Incoming Call.....	10
Redial the Last Number.....	11
Mute/Unmute a Call	11
Turn the Volume Up and Down	12

Streaming Music	13
Quick Access	13
Play and Pause.....	13
Turn the Volume Up and Down	14
Go to the Next/Previous Song	14
Connect to a Wired Device	15
More Functions	16
Active Noise Cancellation.....	16
Add/Remove the Stereo Earpiece	17
Reset to Factory Settings.....	18
Troubleshooting & FAQ	19
Help and Support	20
Warnings, End-User License Agreement, and Warranty	21

What's in the Box

ClearDryve™ 100:

- ClearDryve™ headphone
- Audio cable
- Charging cable
- Drawstring carrying pouch
- Detachable headpad (comes pre-assembled to the headphone)

ClearDryve™ 200:

- ClearDryve™ headphone
- Audio cable
- Charging cable
- Hard-sided carrying case
- Detachable earpiece (comes pre-assembled to the headphone)
- Detachable headpad

ClearDryve™ Parts

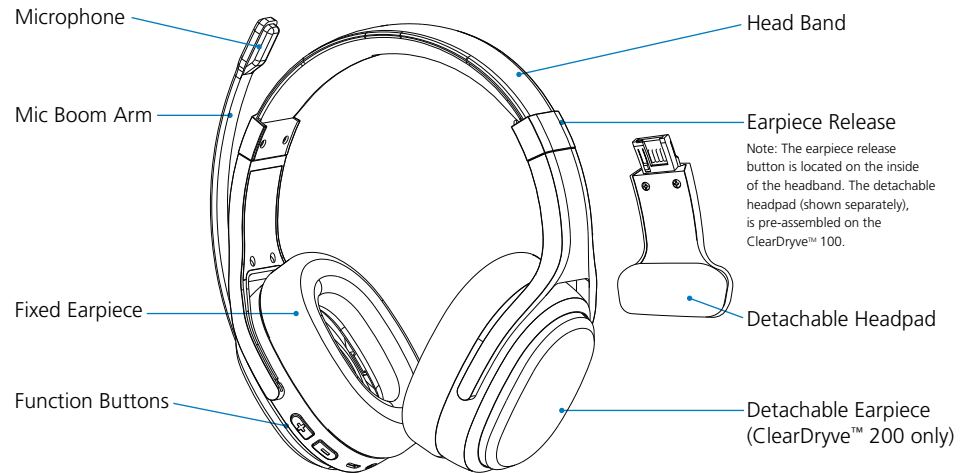

(Dimensions: approx. 8"H x 7"W x 3.25"D)

Function Button Layout

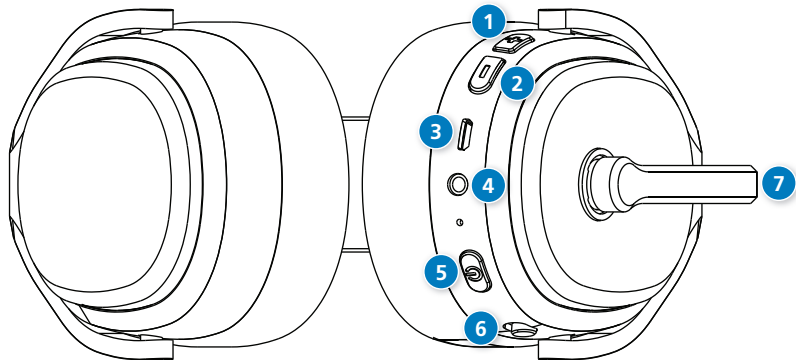

The mic boom arm, ports, LEDs, and function buttons on the ClearDryve™ headphone are on the same earpiece. You can use this earpiece on either ear. ClearDryve™ automatically adjusts for either side when you extend the mic arm. To switch the earpiece with controls from one ear to the other, swivel the mic boom up and over to the other side.

1. **Vol +** button
2. **Vol -** button
3. Micro-USB port
4. 3.5mm audio input
5. **Multi-function button (MFB)**
6. **ANC on/off** slider
7. Mic boom arm

You can press, long-press, and hold the buttons on ClearDryve™. Each does a different function:

1. **Press:** Press the button firmly and release it immediately.
2. **Long-press:** Press the button firmly, and keep it depressed for about a second.
3. **Hold:** Press and hold the button down for the amount of time listed.

Getting Started with ClearDryve™

To get started using ClearDryve™, first you need to charge the battery. After you power it on, then you can pair ClearDryve™ to your Bluetooth® - enabled phone, tablet or laptop. Once ClearDryve™ is paired, you can immediately start taking and managing calls or listening to music.

Charge the Battery

- ✓ Before use, you need to charge the battery on ClearDryve™.
- ✓ Connect the USB cable to the micro-USB port on ClearDryve™. Connect the other end to a charger.
- ✓ If the battery level is low when you power on ClearDryve™, you will hear a "Battery low" notification.

Note: The Active Noise Cancellation feature can be turned on and off independently, regardless of whether the ClearDryve Bluetooth power is turned on or off. This allows you to use the Active Noise Cancellation (ANC) feature even when you are using the included audio cable for "wired mode" usage. **Always remember to turn ANC off by using the slider button, when the headphones are not in use, to prevent your headphones' battery from draining.**

Power ClearDryve™ On and Off

To turn ClearDryve™ on and off:

1. To power ClearDryve™ on, press the **MFB**.
2. You will hear "Power on."
3. To power ClearDryve™ off, press and hold the **MFB**.
4. You will hear "Power off."

When you power ClearDryve™ on for the first time, it automatically enters pairing mode. The next time you turn it on, it will automatically attempt to connect with the most recently-paired device.

Pair with a Device over Bluetooth®

When you power ClearDryve™ on for the first time, it automatically enters pairing mode. In pairing mode, the LED indicator blinks blue, and you will hear "Pairing."

Once a device is paired, the LED stays solid blue. ClearDryve™ will reconnect automatically when Bluetooth® is enabled and the device is within range.

To pair ClearDryve™ with a BT device:

1. **Power** on ClearDryve™.
2. Enable **Bluetooth**® on your device. Leave the device on the Bluetooth Settings screen so it stays in “pairing” mode.
3. ClearDryve™ will display on your device as ClearDryve™. **Select it.**
4. The **LED** will change to solid blue.

You can pair ClearDryve™ to a new device at any time by entering pairing mode again.

To enter pairing mode again:

1. If the headphone is on, turn it off by pressing and holding the **MFB**.
2. Press and hold the **MFB**.
3. The **LED** indicator blinks blue and red, and you will hear **“Pairing.”**

As soon as it is paired with a device, ClearDryve™ is ready to make calls or stream music.

Note: When ClearDryve™ is turned on and not in pairing mode, it will automatically pair with the most recently paired device when it is on.

Call Mode

In Call Mode, you can answer incoming calls, and use your smartphone’s voice assistant to make hands-free calls.

Quick Access

Answer a call	Press the MFB .
End a call	Press the MFB .
Ignore a call	Press and hold the MFB . Note: Holding down the MFB for too long (i.e., over 5 seconds) will cause ClearDryve™ to power down.
Redial	Double-press the MFB
Mute/Unmute	Rotate the mic arm up (to mute) or down (to unmute)
Adjust volume	Press Vol + or Vol -
Wake your smartphone’s voice assistant	Press and hold the MFB (about 3 seconds) Note: You cannot use this feature while on an active call.

Answer an Incoming Call

To answer an incoming call:

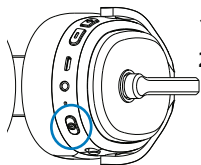

1. Press the **MFB**.
2. ClearDryve™ **will beep once** to confirm. The call will be live immediately.



Note: Make sure the mic boom arm is down.

End a Call

To end a call:

1. Press the **MFB** to hang up.
2. ClearDryve™ **will beep once** to confirm.

Ignore an Incoming Call

To ignore an incoming call:

1. Press and hold the **MFB** for about 2 seconds.
2. ClearDryve™ **will beep once** to confirm.

Note: Holding down the MFB for too long (i.e., over 5 seconds) will cause ClearDryve™ to power down.

Redial the Last Number

To redial the last connected number:

1. Quickly press the **MFB** twice.
2. ClearDryve™ **will beep once** to confirm.

Mute/Unmute a Call

The moveable mic arm provides an easy way to mute or unmute the mic when you are on a call.

To mute the call:

- **Move the mic arm up** and away from your mouth to 65 degrees or more above the horizontal.

To unmute the call:

- **Move the mic arm back down** in front of your mouth.

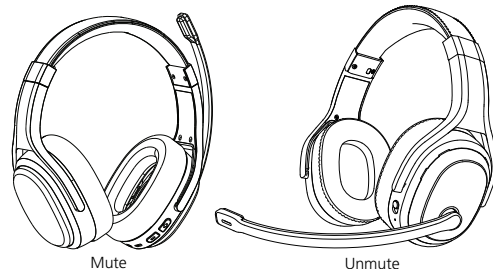

Note: You can use ClearDryve™ with the mic arm on either ear. These steps work the same on both sides. To switch sides, rotate the mic arm all the way around.

Turn the Volume Up and Down

At any time, you can press the volume buttons to turn the volume of the call up or down. There are 16 different volume levels available.

To change the volume:

1. Press **Vol +** to increase the volume.
2. Press **Vol -** to decrease the volume.
3. ClearDryve™ will **beep** when you reach the lowest or highest volume settings.

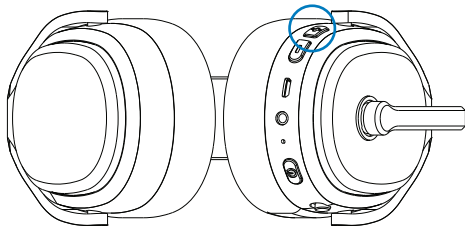

Streaming Music

Quick Access

Play/Pause	Press the MFB
Adjust volume	Press Vol + or Vol -
Next/Previous	Long-press Vol + or Vol -

Play and Pause

To play or pause music:

- Press the **MFB** while in Music Mode.

Note: ClearDryve™ does not have a "Stop" function.

Note: Depending on your device, the volume buttons may behave differently. On some devices the ClearDryve™ volume buttons may control the device volume instead of ClearDryve™ volume.

Turn the Volume Up and Down

At any time, you can press the volume buttons to turn the volume of ClearDryve™ up or down.

There are 16 different volume settings available.

To change the volume:

1. Press **Vol +** to increase the volume.
2. Press **Vol –** to decrease the volume.
3. ClearDryve™ will **beep** when you reach the lowest or the highest volume.

Note: Depending on your device, the volume buttons may behave differently. On some devices the ClearDryve™ volume buttons control the device volume instead of ClearDryve™ volume.

Go to the Next/Previous Song

To switch to a different song:

1. Long-press **Vol +** to advance to the next song.
2. Long-press **Vol –** to go back to the beginning of the current song. Long-press again to go to the previous song.

Connect to a Wired Device

You can connect ClearDryve™ to any standard 3.5mm audio aux jack.

1. **Connect** the included 3.5mm audio cable to the audio in jack on ClearDryve™.
2. **Connect** the cable to the aux out on your music device.

Note: You must use the included aux cable to connect your device to ClearDryve™. When using ClearDryve™ in wired mode, Bluetooth® functions including volume control on the headphone will not work.

More Functions

Active Noise Cancellation

The ClearDryve™ signal processing removes more than 90% of noise reaching the microphone so those on the other end of the call hear you — not the background. This digital noise suppression is always active. In addition, your ClearDryve™ features Active Noise Cancellation (**ANC**), which eliminates the need to “crank up the volume” by canceling out ambient noise reaching **your** ear. The result is a crystal-clear listening experience for you as well.

To turn ANC on or off:

1. Slide the **ANC slider** to the on or off position.
2. When **ANC** is enabled, the green **ANC** light indicator is on.
3. When **ANC** is disabled, the green **ANC** light indicator is off.

Note: ANC can be turned on for use in either Bluetooth® (wireless) or wired mode. When the headphone is not in use, remember to turn the **ANC** slider off to conserve battery power.

Add/Remove the Detachable Stereo Earpiece (ClearDryve™ 200 Only)

ClearDryve™ can convert from mono (one earpiece plus headpad) to stereo (two earpieces). The detachable earpiece can be replaced with the headpad for mono configuration.

To remove the earpiece or the headpad:

1. **Hold** the black earpiece release tab.
2. **Slide** the earpiece off.

To attach the earpiece or the headpad:

3. **Slide** the earpiece/headpad onto the ClearDryve™ head band.
4. The earpiece will **click** when connected.



Reset to Factory Settings

You may need to restore ClearDryve™ back to its factory state, typically when switching over to newer model smartphones / laptops for daily use. Clearing the “pairing history” on your headphones can help improve connection times between your headphones and new devices.

To reset ClearDryve™:

1. Make sure ClearDryve™ is **powered** off. Now press and hold **MFB** to place it in **pairing mode**.
2. Press and hold **Vol -** and **MFB** at the same time until you hear **2 beeps**.

Your ClearDryve’s pairing history is now cleared and it is in pairing mode. You can turn of the headphones or proceed to pair it with your device(s).

Note: The next time you turn on the device, it will automatically be in pairing mode.

Troubleshooting & FAQ

Issue:	Possible Causes:
My headphone need to be charged very frequently.	ANC may be turned ON , even when you are not using the headphone. Be sure to turn off ANC when the product is not in use, to maximize how long your headphone can be used between charges
Can I connect more than one device to my headphone.	Yes, your headphone can be simultaneously connected to more than one device. To add new connections after connecting to the first device, turn off the headphone, then press and hold the MFB . The headphone will enter pairing mode. Follow the steps for your unique device (smartphone, laptop, tablet) to connect to the headphone.
I am confident batteries are fully charged, yet they do not seem to work.	In the rare event that your headphone “locks up,” it can be “rebooted” by pressing and holding the MFB and Vol+ button simultaneously. The headphone will then turn off. Press the MFB to turn on and resume operation.

Help and Support

Contact Rand McNally customer support for assistance:

- By phone: **1-877-446-4863**
- By email: tndsupport@randmcnally.com
- On the web: <http://www.randmcnally.com/support/category/cleardryve>

Warnings, End-User License Agreement, and Warranty

IMPORTANT! Before using this Rand McNally product, you should review applicable law regarding the use of this product, as federal, state or local law may prohibit or otherwise restrict the use of this product while operating a motor vehicle.

WARNING: Safe Driving Practices

Never attend to or handle the headphones while driving. Always use your best judgment and exercise common sense when the vehicle is in motion and do not allow yourself to be distracted by the headphones while driving. Pull over in a safe and legal manner before attempting to attend to or handle the headphones.

End-User License Agreement

Rand McNally hereby grants you ("User") a single-user non-exclusive, non-transferable license to use the software and associated data incorporated in the headphones and related documentation (collectively referred to herein as the "Software Materials") for User's own business or personal use and not for resale, sublicense or commercial use. The Software Materials are furnished under license and may be used only in accordance with this license. Except as permitted by such license, the Software Materials may not be disclosed to any third party, copied or duplicated in any form, in whole or in part, without the prior written permission of Rand McNally. The Software Materials contain proprietary and confidential information of Rand McNally and its licensors. Rand McNally grants User a limited license for use of this product and the Software Materials for its normal operation. By using the Software Materials, User acknowledges that such Software Materials are the property of Rand McNally and its licensors and are protected by U.S. copyright, trademark and patent laws and international treaties.

THE USER MAY NOT:

- Use the Software Materials on a network or file server, for time-sharing or to process data for third parties.
- Copy, loan or otherwise transfer or sublicense the Software Materials or any of its content.
- Modify, adapt, decompile, disassemble, reverse engineer or reduce to human readable form the Software Materials for any purpose whatsoever.
- Alter, remove or obscure any copyright notice, trademark notice, or proprietary legend from the product, the Software Materials or its content.

This license will terminate automatically if User fails to comply with any of the terms of this license and, in such case, User agrees to immediately stop using the Software Materials. Rand McNally may revise or update the product or Software Materials, but is not obligated to furnish any revisions or updates to User.

